



PRICE LIST

ClimaLevel HKL Multi-floor

Dinotherm Underfloor Heating

Validity:

All prices do not include VAT. We reserve the right to make technical modifications and price adjustments. We are unable to accept any liability for printing errors and inaccuracies. All rights reserved. [Status: 2009-07-28]

Kemmer GmbH

Kölner Straße 60
50859 Cologne-Lövenich
Germany

Telephone: +49 (0) 22 34 / 999 19 - 0

Telefax: +49 (0) 22 34 / 999 19 - 20

www.climalevel.com

www.dinotherm.com

We are bringing technology down to earth!

Our solutions for heating, cooling and ventilation together with the space-saving installation of electrical equipment are tried-and-tested and economic.

As well as the planning support, which we provide as a matter of course, we also offer you our assistance during the assembly of these systems. Ask our sales representatives.

This is how it is worked out:

Another mountain of inquiries and projects on the table and time is pressing?

We have already done the preparatory work for you!

You can count on our cost-effective system prices.

When all the details about the project are finally clarified, then further plans can be made. But one thing is for sure: our price – GUARANTEED!

Dinotherm System Prices

Dinotherm Wet System in accordance with DIN 18561, Design A1	6
Dinotherm Dry System in accordance with DIN 18560, Design B	7

ClimaLevel System Prices

ClimaLevel, Comfort and Technology 365 days a year!	8
ClimaLevel dynamic zones	9
ClimaLevel static system surfaces	9
ClimaLevel Pipe Register	10
ClimaLevel Air Supply Ducts	10
Air distribution box	11
Supply air outlet ASR	11

Underfloor Cabling

ClimaLevel Underfloor Cabling	12
ClimaLevel Cavity Electrical Duct	12
Accessories	13
ClimaLevel Electrical Base Socket with round Fixture	13
ClimaLevel Electrical Base Socket rectangular Fixture	13

Distribution Cabinets

Dinotherm Junction Box, Modular 110	14
Dinotherm Junction Box, Modular 75	14
Dinotherm Frames and Doors, modular	15
Dinotherm Wall-Mounted Hood, modular	15
Wall-Mounted Cabinet, compact	15

Distributor Technology

Dinotherm M-Line Distributor	16
M-Line Bracket Set 75	17
M-Line connection set DG	17
M-Line connection set corner	17
M-Line Connection Set Corner-Multi	17
M-Line Thermometer Set	17
M-Line Heat Meter Connection Set	18
M-Line Heat Meter Connection Set DRG	18
M-Line Extension EM-PT	18
Connection Accessories	18
Dinotherm Fixed value Compound Set Comfort	19

Control Technology

“LISA” Control Unit for Heating and Cooling	20
Dinotherm Room Thermostat	20
Dinotherm Room Thermostat 24 V, H-C	21
Dinotherm Servomotor	21
Dinotherm Control Distributor	21
Dinotherm H-C-Drive	21
Expansions for Control Distributor	22
Dinotherm Radio Base	22
Room Thermostat Controller H-C	22

Heating surfaces

Dinotherm Heating pipe VerPE 5 dd	23
ClimaLine Heating Pipe VerPEflex 3 dd	23
ClimaLine Heating Pipe PEXc 5 dd	23
Tempus MPC Pipe	23
Dino 30-2 plus System panel	24
Dinofix Guide Rails with Grid-Printed Foil	24
Dino 30-2 S Heavy Duty Panel	24
Screed Matting	24
Dry construction panel TR 30	25
Plasterboard TR 30	25
Thermal Conduction Panels	25
Pipe Anchorage	25
Perimeter Insulating Strips and Expansion Joints	25
Heating Surface Accessories	26
Filling material	26
Dinotherm Screed Additive	26
PE-Foil 0.2 mm	26
Knauf Waterproofing Sheets	27
Additional insulation	27

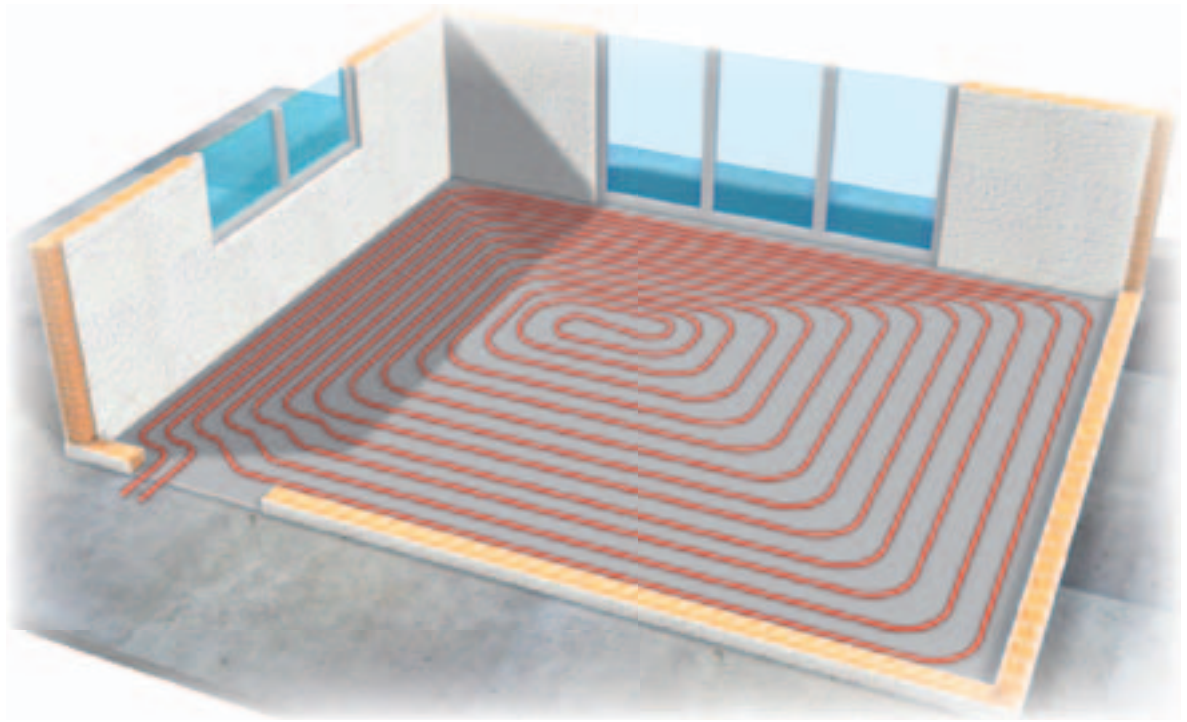

Dinotherm Wet System in accordance with DIN 18561, Design A1

Dinotherm underfloor heating with various installation intervals depending on the construction in accordance with EN 1264. The system consists of: heat and impact sound installation using Dinotherm system panels, joint tape to seal against screed water, perimeter insulation strips with foil plating, diffusion-proof Dinotherm heating pipe 17 x 2 mm with brackets and proportionate Dinotherm M-Line heating circuit distributor with flow meter and DG connecting kit. (Basis of delivery: Measurements of our estimate, rounded to sales unit. Invoice: rounded to 10 m²)

System panel	Dinotherm installation for operation with heat pumps (supply-temperature approx. 35°C), Heating capacity approx. 50 W/m ²	Dinotherm installation for operation with boiler (supply-temperature approx. 45°C), Heating capacity approx. 80 W/m ²
Dinofix 20-2 R = 0.44 m ² K/W 28 dB, 4 kN/m ²	Art.-No. DT2035 21.50 € /m ²	Art.-No. DT2045 18.60 € /m ²
Dinofix 25-2 R = 0.55 m ² K/W 28 dB, 4 kN/m ²	Art.-No. DT2535 21.70 € /m ²	Art.-No. DT2545 18.80 € /m ²
Dinofix 30-3 R = 0.66 m ² K/W 28 dB, 4 kN/m ²	Art.-No. DT3035 22.20 € /m ²	Art.-No. DT3045 19.30 € /m ²
Dinofix 35-3 R = 0.75 m ² K/W 28 dB, 4 kN/m ²	Art.-No. DT3535 22.90 € /m ²	Art.-No. DT3545 20.10 € /m ²
Dinofix 30-2 plus! R = 0.75 m ² K/W 28 dB, 5 kN/m ²	Art.-No. DT4035 22.90 € /m ²	Art.-No. DT4045 20.10 € /m ²

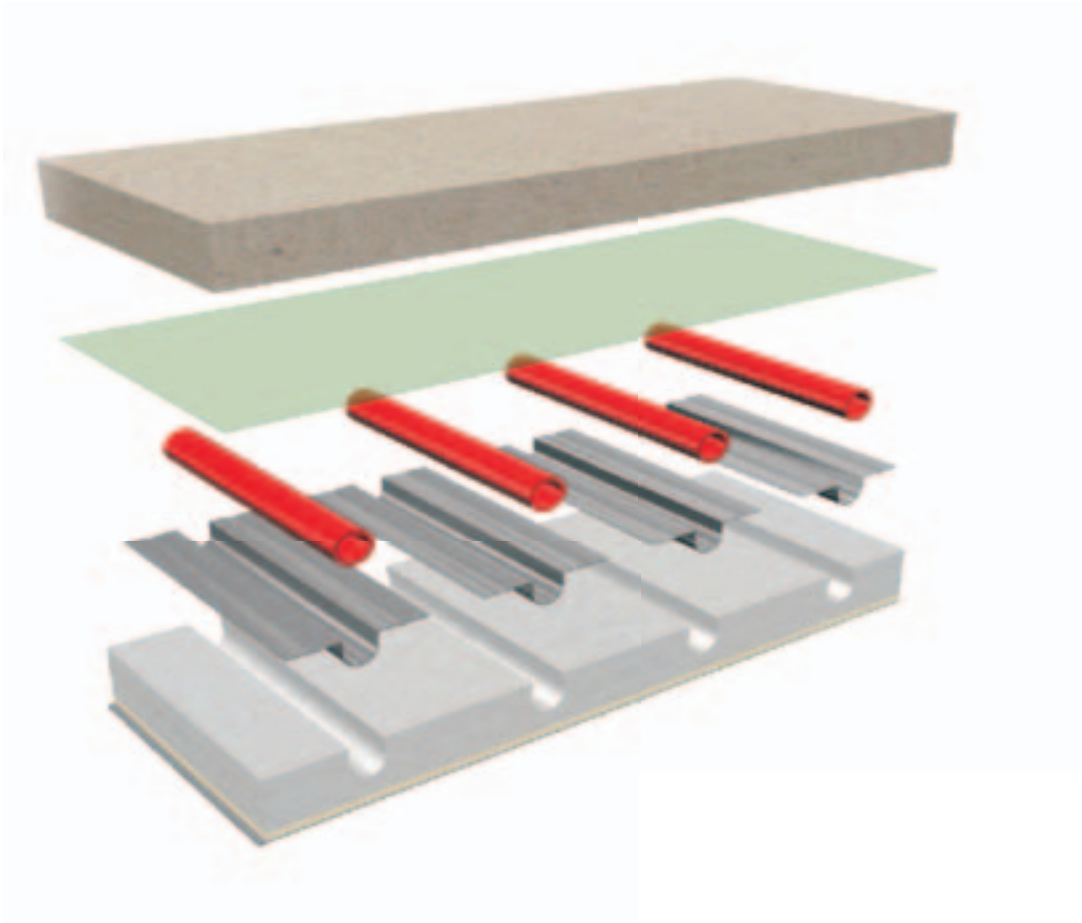

Dinotherm Dry System in accordance with DIN 18560, Design B

Dinotherm underfloor heating with TR 30 grooved profile panels. Laying panel made from EPS 035 DEO dh with pipeline channels. TR 30 enables the installation of 16 mm heating pipes on solid wood and wooden beam floors using a dry construction procedure or with heating screed in accordance with DIN 18560 on PE foil. The surface structure permits heating pipe channels for single and dual meander laying. Installation interval 125 and 250 mm. building material class B1 in accordance with DIN 4102.

A thermotechnical inspection and Fermacell factory approval for the application ranges 1, 2 and 3 in accordance with DIN 1055 exist. Compression strength at 2 % compression: ≥ 45 kPa
R-value = $0.75 \text{ m}^2 \text{ K/W}$ (thermal conductivity: 0.035 W / (mK))

Note:

- When using thermal insulation in connection with dry screed elements, a minimum of EPS 035 DEO (with 150 kPa with 10% compression) must be provided!
- When using thermal or impact sound insulation in connection with dry screed elements, usage must be agreed with the manufacturer of the dry screed elements!

System price with system panel TR 30, PE-Foil 0.2 mm as cover, heating pipes in acc. with VA and heat conducting panels should be calculated separately.	Dinotherm installation for operation with heat pumps (supply-temperature approx. 35°C), Heat capacity based on surface with $R_\lambda = 0.10 \text{ m}^2\text{K/W}$	Dinotherm installation for operation with boiler (supply-temperature approx. 45°C), surface with $R_\lambda = 0.10 \text{ m}^2\text{K/W}$
VA 12.5	Art.-No. TR1235 54.00 € /m ² q = 38 W/m ²	Art.-No. TR1245 54.00 € /m ² q = 58 W/m ²
VA 25	Art.-No. DT2535 21.70 € /m ² q = 26 W/m ²	Art.-No. DT2545 18.80 € /m ² q = 40 W/m ²

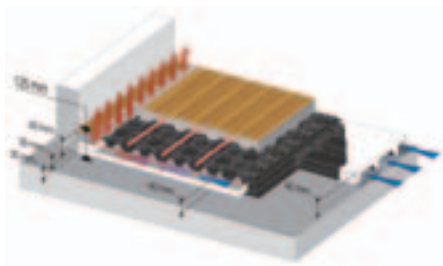
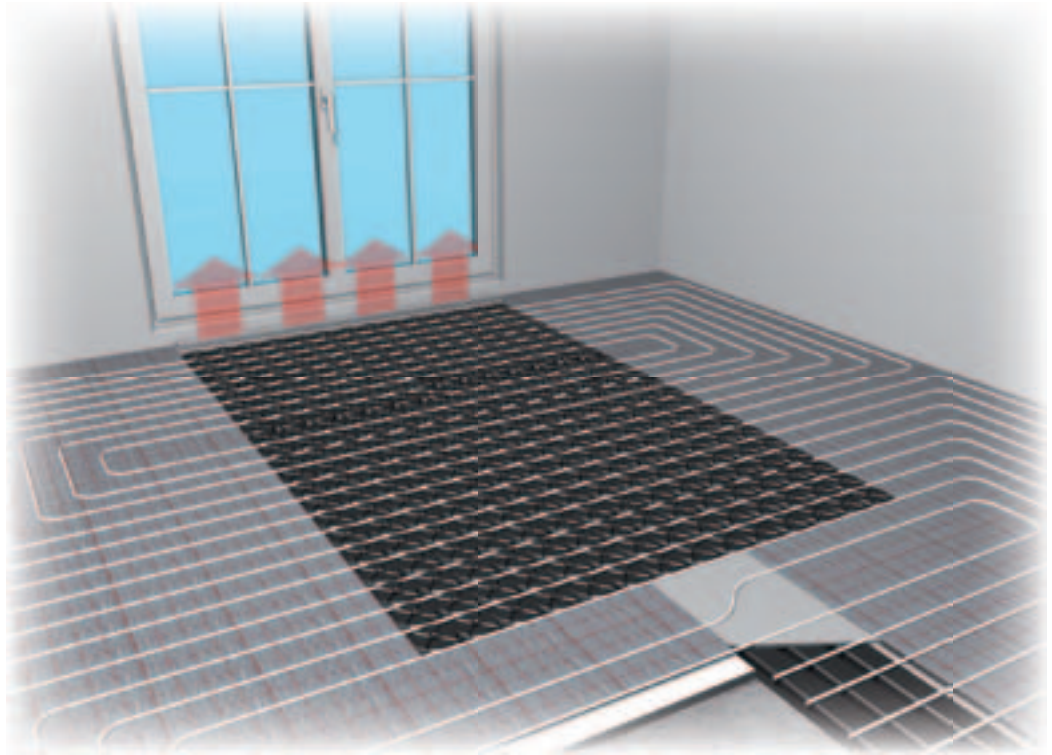

Construction version 1

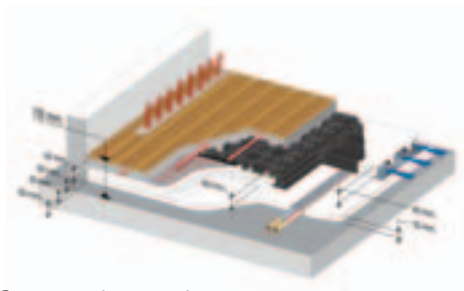

Construction version 2

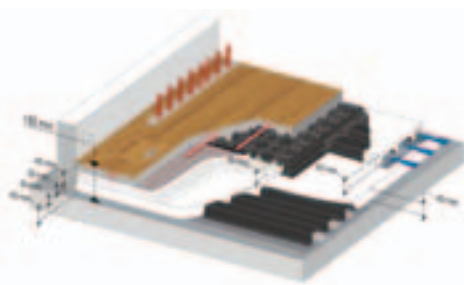

Construction version 3

ClimaLevel, Comfort and Technology 365 days a year!

System flooring for heating, cooling, ventilation and cabling. Installation with floating screed and integrated impact sound improvement of 28 dB.

- Dynamic areas as ventilated cavity floors for thermal handling of supply air with 30 mm high air space. The cavity flooring elements have pipe holding knobs on the top side and support feet on the lower side, which are established by applying screed.
- Static areas as hot water underfloor heating in accordance with DIN 18 560, Design A1. Variable installation intervals to adjust the heating and cooling capacities.

ClimaLevel dynamic zones

consisting of: cavity flooring elements to form a cavity floor zone which air passes through, connection profiles, inflow profiles for the dynamic zones and T-profiles with assembly block for the floor air outlet.

Art.-No.	Description	Price
CL1006	Dynamic zone 100-6 6 m ² cavity flooring for ca. 100 m ³ /h	395.- €/Pce.
CL1004	Dynamic zone 100-4 4 m ² cavity flooring for ca. 100 m ³ /h	310.- €/Pce.
CL0503	Dynamic zone 50-3 3 m ² cavity flooring for ca. 50 m ³ /h	275.- €/Pce.
CL0502	Dynamic zone 50-2 2 m ² cavity flooring for ca. 50 m ³ /h	220.- €/Pce.
CL0501	Extension set 1 m ² cavity flooring for zone extension	67.- €/Pce.

ClimaLevel static system surfaces

Floor construction for flush mounting with dynamic zones in accordance with the ClimaLevel installation design to be used. Floor construction consists of: additional insulation from EPS 040, thickness in accordance with design details, CL 30-2 plus 5 laying panel, perimeter insulation strips and expansion joint profiles.

Art.-No.	Description	Price
CL7501	Static System surface Var.1, Height 60 mm (without screed and floor covering)	15.50 €/m ²
CL7502	Static System surface Var.2, Height 90 mm (without screed and floor covering)	22.60 €/m ²
CL7503	Static System surface Var.3, Height 120 mm (without screed and floor covering)	29.10 €/m ²

ClimaLevel Pipe Register

Configuration of static and dynamic areas with ClimaLine heating pipe 17x2 mm including pipe brackets as per heating or cooling capacity. Price includes heating circuit distributors with flow meters.

Art.-No.	Description	Price
CL7601	Pipe Register H 40 „Heating“	13.90 €/m ²
CL7602	Pipe Register HK 35 „Heating and cooling“	17.40 €/m ²

ClimaLevel Air Supply Ducts

Routing of air flow using plastic ducts from inflow in the ground to the dynamic zones. Price includes duct support panel made of 0.5 mm polystyrene webbing and duct cover.

Technical data:

Pressure loss approx. 5 Pa/m at 130 m³/h

Material: Polystyrene 1.5 mm Length: 1050 mm

Dimensions: 3 x 45 x 110 mm

Impact sound improvement (with duct cover) 28 dB

Sound insulation capacity by static air: >40 dB!

Art.-No.	Description	Price
CL7003	KST Supply air with footfall cover	41.90 €/m

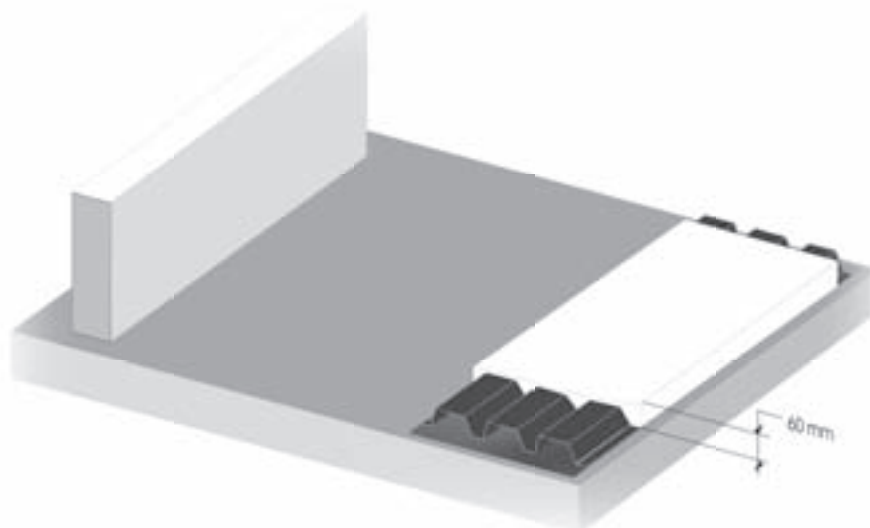

Supply air duct with impact sound cover.

Air distribution box

Made of polystyrene. MDF-reinforced. From 1 to 4 connections. With blank cover and fixing foot.
Capacity up to approx. 180 m³/h.

Art.-No.	Description	Price
CL305X	Air distribution box 1AB / 2DB / 2WB / 3AB / 4AB	132.- €/Pce.



Supply air outlet ASR

Cavity floor outlet made of compressed aluminium with brushed surface. With control mechanism for directing air outflow. Price including side end covers.

Art.-No.	Description	Price
CL2010	ASR 19-1/500 mm	190.- €/Pce.
CL2020	ASR 19-1/1000 mm	215.- €/Pce.
CL2030	ASR 19-1/1500 mm	308.- €/Pce.
CL2040	ASR 19-1/2000 mm	395.- €/Pce.



ClimaLevel Underfloor Cabling

The ClimaLevel duct system is a screed-covered underfloor system. It consists of: profiled polystyrene moulds, which are installed on the bare floor with an unrolled mould base. The ductwork moulds are profiled with three tracks as standard (high-voltage current, telecommunication and data systems technology), whereby the individual tracks are separated by gaps, which have contact areas with the bare floor.

The inside of the mould elements are bevelled on the grooves so that lines can be fed in without problems. At the points, at which flush installation units (device units) or pull box inserts, so for example at branch connections and intersections, should be installed, underfloor socket moulds are positioned with vertical installation supports. The cabling system can be combined without any problems with the Dinotherm underfloor heating and ClimaLevel HKL-Multi-floor.

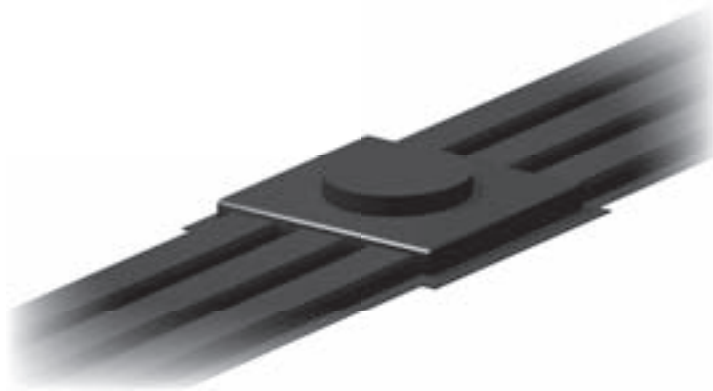

Basic socket with duct interface

ClimaLevel Cavity Electrical Duct

Consisting of:

duct element with sleeve, 3-track for installation on the duct support panel as a downward opening thermoformed profile made of 1.5 mm thick polystyrene.

Length: 1050 mm (Usable length: 1000 mm), Nominal height: 45 mm,

Channel dimensions: 3 x 110 mm

Impact sound improvement in connection with duct cover 28 dB

Duct underlay made of polystyrene –yard ware, for laying on the bare floor as underlay for the

Duct element 0.5 mm thick, 500 mm wide

duct cover, made of polystyrene hard foam for covering the ducts, combatable with duct element,

Nominal height 45 mm; edge cover: 60 mm

Art.-No.	Description	Price
FL7001-45	Electrical duct NH45 with underlay and sound impact cover	41.90 €/m

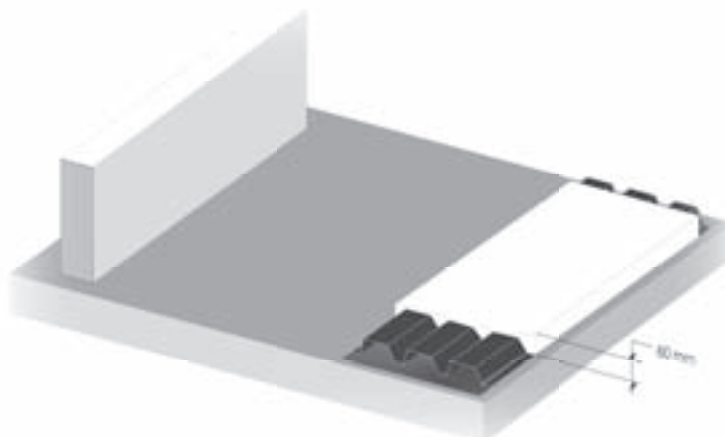

Accessories

Art.-No.	Description	Price
FL1014	Duct connector NH45	4.10 €/Pce.
FL1015	Slip-in socket NH45	9.50 €/Pce.
FL1016	End cap NH45	7.50 €/Pce.
FL1018	Horizontal bend NH45, 5°	8.50 €/Pce.
FL1019	Horizontal bend NH45. 10°	8.50 €/Pce.
FL1020	Horizontal bend NH45, 15°	8.50 €/Pce.
FL1021	Vertical bend NH45	21.- €/Pce.

ClimaLevel Electrical Base Socket with round Fixture

with 1-4 duct connections including the socket support for the installation of flush electrical installation units with support and two duct connectors.

Socket support: round, d = 305 mm, height = 110 mm

Material: polystyrene 1.5 mm

For Electraplan / Ackermann installation units

Art.-No.	Description	Price
FL6001	E- Base Socket X- round, 310x110	67.- €/Pce.

Other designs and adjustments to installation units available on request!

ClimaLevel Electrical Base Socket rectangular Fixture

With 1-4 duct connections including the socket support for the installation of flush electrical installation units with support and two duct connectors.

Socket support: rectangular, 310 x 310 mm, Height= 160 mm

Material: Polystyrene 1.5 mm

For Electraplan / Ackermann installation units

Art.-No.	Description	Price
FL6002	E- Base Socket X-rectangular, 310x160	70.- €/Pce.

Further versions and adaptations to installation units on request!

Dinotherm Junction Box, Modular 110

Height-adjustable junction box with plaster grid, pipe diversion track and lateral blanking for the connection lines. Depth 110 mm.

Art.-No.	Description	Price
FB 5701	Junction box DV 1-110 width = 450 mm	63.- €/Pce.
FB 5702	Junction box DV 2-110 width = 680 mm	77.- €/Pce.
FB 5703	Junction box DV 3-110 width = 830 mm	81.- €/Pce.
FB 5704	Junction box DV 3-110 width = 1.140 mm	95.- €/Pce.

Dinotherm Junction Box, Modular 75

Height-adjustable Junction box with plaster grid, pipe diversion track and lateral blanking for the connection lines. Depth 75 mm! DMLV attachment kits 75 (FB 2031) are required to install the distributor

Art.-No.	Description	Price
FB 5701-75	Junction box DV 1-75 width = 450 mm	68.- €/Pce.
FB 5702-75	Junction box DV 2-75 width = 680 mm	85.- €/Pce.
FB 5703-75	Junction box DV 3-75 width = 830 mm	91.- €/Pce.
FB 5704-75	Junction box DV 4-75 width = 1.140 mm	104.- €/Pce.



Dinothem Frames and Doors, modular

Depth-adjustable front blanks with doors in RAL 9010, suitable for Dinothem 110 and 75 Junction boxes.

Art.-No.	Description	Price
FB 5711	Concealed frame DR 1	69.- €/Pce.
FB 5712	Concealed frame DR 2	91.- €/Pce.
FB 5713	Concealed frame DR 3	101.- €/Pce.
FB 5714	Concealed frame DR 4	121.- €/Pce.



Dinothem Wall-Mounted Hood, modular

Front hood in RAL 9010 to cover 110 and 75 junction boxes for front-wall assembly.

Art.-No.	Description	Price
FB 5721	Wall-Mounted Hood DH 1	81.- €/Pce.
FB 5722	Wall-Mounted Hood DH 2	101.- €/Pce.
FB 5723	Wall-Mounted Hood DH 3	123.- €/Pce.
FB 5724	Wall-Mounted Hood DH 4	127.- €/Pce.



Wall-Mounted Cabinet, compact

Universal wall-mounted distributor cabinet made from 1 mm galvanised and powder-coating sheet steel. Colour: traffic white. Height-adjustable between 620 and 690 mm, depth 125 mm. Plug-in door with cabinet bolt, removable screed deflector, 2 mounting rails to incorporate the heating circuit distributor.

Art.-No.	Description	Price
FB 5202	Wall-Mounted Cabinet AVS 105 (width =580 mm)	120.- €/Pce.
FB 5203	Wall-Mounted Cabinet AVS 110 (width =732 mm)	130.- €/Pce.
FB 5204	Wall-Mounted Cabinet AVS 120 (width =882 mm)	140.- €/Pce.
FB 5206	Wall-Mounted Cabinet AVS 140 (width =1.182 mm)	170.- €/Pce.



Dinotherm M-Line Distributor

Nickel-plated distributor, consisting of: flow collector with thermostat valves, return bars with flow meters (0.5 to 2.5 l/min), each with preformed 1" swivel nut.

Distributor complete with drainage and manual bleeding device, pre-installed on plastic brackets.

Name plate with primary pressure that can be labelled as desired is enclosed

Art.-No.	Description	Price
FB 5802	M-Line Distributor DMLV 2	139.- €/Pce.
FB 5803	M-Line Distributor DMLV 3	179.- €/Pce.
FB 5804	M-Line Distributor DMLV 4	220.- €/Pce.
FB 5805	M-Line Distributor DMLV 5	262.- €/Pce.
FB 5806	M-Line Distributor DMLV 6	303.- €/Pce.
FB 5807	M-Line Distributor DMLV 7	344.- €/Pce.
FB 5808	M-Line Distributor DMLV 8	385.- €/Pce.
FB 5809	M-Line Distributor DMLV 9	426.- €/Pce.
FB 5810	M-Line Distributor DMLV 10	466.- €/Pce.
FB 5811	M-Line Distributor DMLV 11	521.- €/Pce.
FB 5812	M-Line Distributor DMLV 12	583.- €/Pce.



M-Line Brachet Set 75

Special bracket for mounting M-Line distributors in distributor box with minimal construction height

Art.-No.	Description	Unit Size	Price
FB 2031	DMLV Bracket Set 75	2 Pce.	12.- €/Set

M-Line connection set DG

Consists of: 2 ball valves with $\frac{3}{4}$ " internal thread connections.

Art.-No.	Description	Price
FB 5850	M-Line Connection DG	27.- €/Set



M-Line connection set corner

Consists of: 2 corner ball valves with for off-set connection with $\frac{3}{4}$ " internal thread connections.

Art.-No.	Description	Price
FB 5851	M-Line Connection Corner	41.- €/Set



M-Line Connection Set Corner-Multi

Consists of: 1 corner valve and one corner ball valve and 1 corner regulating valve for direct distributor balance.

Art.-No.	Description	Price
FB 5852	M-Line Connection Corner-Multi	65.- €/Set



M-Line Thermometer Set

Consisting of 2 thermometers with fastening spring.

Art.-No.	Description	Unit Size	Price
FB 5855	M-Line Thermometer Set	2 Pce.	45.- €/Set



M-Line Heat Meter Connection Set



Extension set for conventional heat meter. Contains 2 shut-off valves, 1 sensor valve and a spacer for 3/4" x 110 and 1" x 130 mm heat meters.

The heat meter is not included in the scope of delivery!

Art.-No.	Description	Price
FB 5860	HM-Set M-horizontal	126.50 €/Set
FB 5861	HM-Set M-vertical	149.80 €/Set



M-Line Heat Meter Connection Set DRG

Extension set with pressure regulation for commercially available heat meters. Includes 1 shut-off ball valve, 1 line regulating valve, 1 sensor ball valve as well as a spacer for Heat Meter 3/4" x 110 and 1" x 130 mm.

The heat meter is not included in the scope of delivery!

Art.-No.	Description	Price
FB 5863	HM-Set M-horizontal	231.- €/Set
FB 5864	HM-Set M-vertical	255.- €/Set



M-Line Extension EM-PT

Screw-on distributor expansion for an additional heating circuit.

Art.-No.	Description	Unit Size	Price
FB 5854	M-Line extension EM-PT	1 x supply 1 x return temp.	124.- €/Set

Connection Accessories

Connection and transfer screws on 3/4" Eurokonus basis.

Art.-No.	Description	Unit Size	Price
FB 1049	Compression fitting 14x2 mm	2 Pce.	3.30 €/Pce.
FB 1051	Compression fitting 16x2 mm	2 Pce.	3.30 €/Pce.
FB 1050	Compression fitting 17x2 mm	2 Pce.	3.30 €/Pce.
FB 1052	Compression fitting 20x2 mm	2 Pce.	3.30 €/Pce.
FB 1061	Double nipple 3/4" For the production of couplings	1 Pce.	2.60 €/Pce.
FB 1060	Outlet nipple 3/4" x 1/2" For connection to radiator valves	1 Pce.	2.60 €/Pce.

Dinotherm Fixed value Compound Set Comfort

Pump and control unit as fixed value compound set to connect to heating systems with increased supply water temperatures. Serves to install a separate "underfloor" heating circuit.

Hydraulic separation of primary and secondary pumps through integrated water point.

Set consists of: 3-stage circulation pump, thermostat head with attached sensor, control distributor with pump relay, temperature monitor, servomotor for water point.

Art.-No.	Description	Unit Size	Price
FB 5871	FM-Set Comfort	1 Pce.	810.- €/Pce.

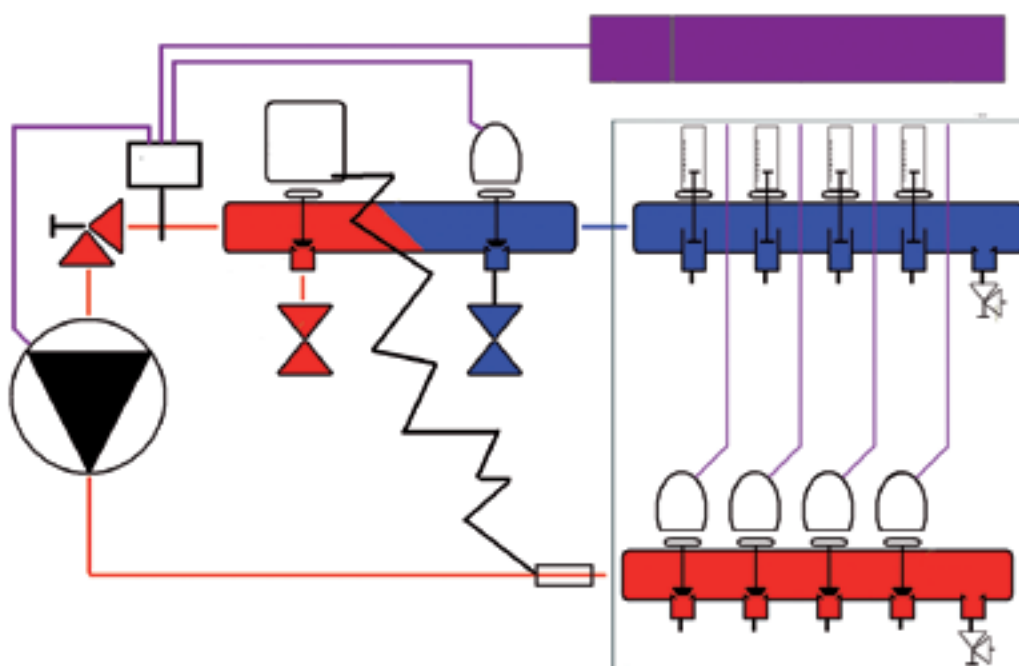

“LISA” Control Unit for Heating and Cooling

AT-routed control unit to control heating and cooling operational modes with switch-over and regulation of relevant supply temperature. Contoller incl. external, supply and moisture sensors.

Art.-No.	Description	Price
CL 9001	ClimaLevel Multi-control „LISA“	590.- €/Pce.
CL 9004	Return flow sensor „LISA“	45.- €/Pce.
CL 9002	2-Duct Analogue clock „LISA“	105.- €/Pce.
CL 9005	Room station „LISA“	59.- €/Pce.

Dinothem Room Thermostat

Electronic room temperature regulator with relay shut-off, pulse-width modulation. Possible temperature reduction by 4 K through external timer, differential gap 0.5 K. Mode limitation and target value comparison. Wall-mounted installation or as embedded socket.

Normally closed for max. 10 thermoelectrical drives.

Art.-No.	Description	Price
FB 4001M	Dinothem room thermostat 230 V	23.50 €/Pce.
FB 4009M	Dinothem room thermostat regulator 24 V	23.50 €/Pce.



Dinotherm Room Thermostat 24 V, H-K

Electronic room temperature regulator, including mounting plinth for heating / cooling function, temperature reduction / temperature increase 2-6 K, pulse-width modulation, input for external changeover signal between heating and cooling operation, selector switch for operating modes, temperature range 10-28 °C, mode limitation.

Art.-No.	Description	Price
CL 9056	Dinotherm room temperature regulator 24 V H-K	99.- €/Pce.



Dinotherm Servomotor

Thermoelectrical drive with functional display.
Drive normally closed, with „first open” function.
Particularly protected against splash water, IP 54.

Art.-No.	Description	Price
FB 4004M	Dinotherm Servomotor 230 V	24.- €/Pce.
FB 4008M	Dinotherm Servomotor 24 V	24.- €/Pce.



Dinotherm Control Distributor

Terminal strip to wire thermo-electrical drives with room thermostat.
Functional expansion through plug-in modules.
Suitable for installation in the distribution cabinet.
24 V design includes a transformer

Art.-No.	Description	Price
FB 6006A	Control Distributor 230 V-6 6 Controllers -12 Drives	82.- €/Pce.
FB 6033M	Control Distributor 24 V-6 6 Controllers -12 Drives	115.- €/Pce.
FB 6021	Control Distributor 230 V-1 1 Controllers -4 Drives	54.- €/Pce.
FB 6025	Control Distributor 24 V-1 1 Controllers -4 Drives	88.- €/Pce.



Dinotherm H-C-Drive

Plug-in expansion of the 24 V base control distributor to convert the 24 V, H-C room thermostat into heating or cooling operation.

Art.-No.	Description	Price
CL 9055	H-C Module alpha 24V	92.- €/Pce.



Expansions for Control Distributor

Plug-in expansion module for the base control distributor, to supplement existing connection options.

Note: The control distributor including expansion must not exceed a total of 14 thermoelectrical drives.

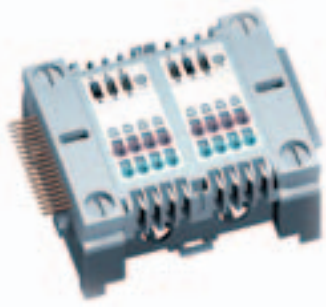

Art.-No.	Description	Price
FB 6022	Drive module 230 V (more than 4 circuits per controller)	44.- €/Pce.
FB 6035	Drive module 24 V	45.- €/Pce.
FB 6023	Control module 230 V (Extended by 2 controllers)	36.- €/Pce.
FB 6036	Control module 24 V	37.- €/Pce.
FB 6024	Pump module 230 V (Pump shut-off.)	79.- €/Pce.
FB 6034	Pump module 24 V	79.- €/Pce.
FB 6025	Time module with 2-duct digital clock (2 heating zones)	170.- €/Pce.

Dinothem Radio Base

Base terminal strip with 24 V transformer as receiver unit to incorporate up to max. 6 or 12 remote room temperature controllers. Frequency: 868 MHz.



Art.-No.	Description	Price
FB 7002	Radio control 6 K (Connection max. 6 regulators)	310.- €/Pce.
FB 7003	Radio control 12 K (Connection max. 12 regulators)	439.- €/Pce.

Dinothem Remote Controller H-C

Battery-operated, electronic room temperature regulator including mounting plinth for wireless transmission of signals to remote terminal strip. Frequency: 868 MHz. In connection with H-C-Drive no. CL 9055, also suitable for heating/cooling function.



Art.-No.	Description	Price
FB 7001	Remote regulator H-C	91.- €/Pce.

Dinotherm Heating pipe VerPE 5 dd

5-layer, diffusion-proof and flexible quality pipe made of polyethylene. Increased temperature resistance (Dowlex 2388). Impermeability against diffusion considerably below the DIN threshold. Quality-inspected and externally monitored.



Art.-No.	Description	Unit Size	Price
FB 1001	VerPE pipe 5 dd 17x2 mm	200 m 600 m	0.98 €/m
FB 1094	VerPE pipe 5 dd 20x2 mm	200 m 600 m	1.60 €/m

ClimaLine Heating Pipe VerPEflex 3 dd

3-layer, diffusion-proof and flexible quality pipe made of Flexolen. Tight and twist-free laying, even at low temperatures. Quality-inspected and externally monitored.

Art.-No.	Description	Unit Size	Price
FB 1004	VerPEflex pipe 16x2 mm	200 m 600 m	0.98 €/m
FB 1002	VerPEflex pipe 17x2 mm	200 m 600 m	0.98 €/m

ClimaLine Heating Pipe PEXc 5 dd

5-layer, diffusion-proof quality pipe made of cross-linked polythene. Diffusion level is substantially below DIN threshold. Quality-inspected and externally monitored.

Art.-No.	Description	Unit Size	Price
FB 1100	PEXc pipe 5 dd 16x2 mm	200 m 600 m	0.98 €/m
FB 1090	PEXc pipe 5 dd 17x2 mm	200 m 600 m	0.98 €/m
FB 1091	PEXc pipe 5 dd 20x2 mm	200 m 600 m	1.60 €/m

Tempus MPC Pipe

Metal-plastic compound pipe, produced in accordance with DIN 16836. Dimensionally stable and oxygen-proof.

Art.-No.	Description	Unit Size	Price
FB 1092	Tempus MPC pipe 16x2 mm	200 m	1.60 €/m

Dino 30-2 plus System panel

3x folded stable laying panel made of EPS sm 040 with grid-printed foil.
R-value: 0.75 m²K/W. Impact sound improvement: 28 dB
Compression strength: 5 kPa/m²



Art.-No.	Description	Unit Size	Price
FB 2027	Dino 30-2 plus	12 m ²	8.10 €/m ²

Dinofix Guide Rails with Grid-Printed Foil

Thermal and impact sound insulation made from quality-monitored polystyrene foam in accordance with DIN 13163. Surface made from tear-resistant and waterproof grid-printed foil.

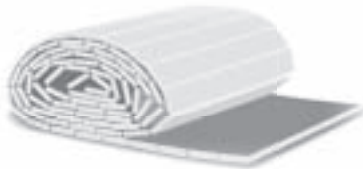

Art.-No.	Description	Unit Size	R-value (m ² K/W)	M-Load (kPa/m ²)	Price
FB 2023	Dinofix 15-2	16 m ²	0.33	4.00	6.50 €/m ²
FB 2024	Dinofix 20-2	10 m ²	0.44	4.00	5.90 €/m ²
FB 2014	Dinofix 25-2	10 m ²	0.56	4.00	6.10 €/m ²
FB 2010	Dinofix 30-3	10 m ²	0.67	4.00	6.60 €/m ²
FB 2011	Dinofix 35-3	10 m ²	0.75	4.00	7.40 €/m ²

Dino 30-2 S Heavy Duty Panel

Laying panels from EPS sm 035 with tacker foil for use with increased compression loads up to max. 10 kPa/m². Impact sound improvement: 26 dB

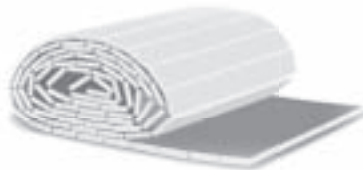

Art.-No.	Description	Unit Size	R-value (m ² K/W)	M-Load (kPa/m ²)	Price
FB 2026	Dino 30-2 S	10 m ²	0.86	10.00	11.20 €/m ²

Screed Matting

Grid matting to fix pipes to insulation or PE foil.
Grid dimensions: 150 mm. Wire gauge: 3 mm

Art.-No.	Description	Unit Size	Price
FB 1007	Screed mat 150-3	25.20 m ²	4.20 €/m ²

Dry construction panel TR 30

Plasterboard TR 30

Laying element TR 30, produced from quality-monitored EPS 035 DEO dh polystyrene foam in accordance with DIN EN 13163. To install Design B-type underfloor heating in accordance with DIN 18560 and DIN EN 1264 on solid wood and wooden beam floors in connection with wet screed or dry screed elements

Panel size/Usable size: 1000 x 500 x 30 mm Installation interval: 125 and 250 mm
 Traffic load: max. 45 kPa/m² Heat conductivity: 0.035 W / (m · K)
 Heating pipe dimension: 16 mm Thermal resistance: R = 0.75 m² · K/W



Art.-No.	Description	Unit Size	Price
FB 2020	Dry construction panel TR 30	5 m ²	13.90 €/m ²

Thermal Conduction Panels

Profiled and galvanised sheet steel with pre-cut predetermined breaking points, approx. 250 mm spacing for even load and thermal distribution.

Heating pipe dimension: 16 mm
 Dimensions: 997 x 120 x 0.4 mm

Art.-No.	Description	Unit Size	Price
FB 2022	Guiding panel WLB 1000	1 m	4.80 €/m

Pipe Anchorage

Art.-No.	Description	Unit Size	Price
FB 9003	Insulation clip	300 Pce.	0.12 €/Pce.
FB 9003K	Insulation clip „short“ (for Dinofix 15-2)	300 Pce.	0.14 €/Pce.
FB 600X	Clip fixing rail, self-adhesive (pipes 16 to 20 mm)	10 m	2.50 €/m

Perimeter Insulating Strips and Expansion Joints

Components for the production of a floating screed in accordance with DIN 18 560. Compressibility of the edge insulating strip 5 mm. Joint arrangement in accordance with DIN.

Art.-No.	Description	Unit Size	Price
FB 2003	Edge insulating strip 8x140 with foil	50 m	0.60 €/m
FB 2008SC	Fixing rail for 2-piece expansion joint profile	2 m	3.40 €/m
FB 2008AE	Expansion strip AE 12x100 for 2-piece expansion joint profile	2 m	3.90 €/m
FB 2008T	1-piece Expansion strip AE 100 With self-adhesive foot	2 m	5.70 €/m
FB 1137	Cardboard angle 80x40 (Separation of screed surfaces)	8 m	2.55 €/Pce.

Heating Surface Accessories

Art.-No.	Description	Unit Size	Price
FB 3002	Protective pipes 400 mm for expansion joint crossings	10 Pce.	0.75 €/Pce.
FB 2009	Joint tape for sealing butt joints	1 Pce.	4.10 €/Ro
FB 3004	Screed measuring point for damp measuring	1 Pce.	7.70 €/Pce.

Filling material

To process and compensate for multi-layer laying

Art.-No.	Description	Unit Size	Price
FB 2028	Perlite Staubex Insulation filler	150 l	25.- €/Sa
FB 2028-M	Mehabit Bituminous filler	100 l	45.- €/Sa

Dinotherm Screed Additive

Liquid additive to produce cement-bound screed in connection with underfloor heating with particular consideration to increasing the thermal conductivity. Using the plastication process, processing is made easier. Pressure and tensile strength of the screed are increased. 1 kg is enough for approx. 6-7 m² screed.

Art.-No.	Description	Unit Size	Price
FB 3001	Screed supplement	10 l	4.10 €/l

PE-foil 0.2 mm

Separating foil to support bituminous sealing sheets.
Prevents plasticiser migration

Art.-No.	Description	Unit Size	Price
FB 2015	PE-foil 0.2 mm	100 m ²	0.90 €/m ²

Knauf Waterproofing Sheets

Sealant against floor moisture on bare floors which come into contact with soil, in accordance with DIN 18195-4. Sd value > 1,500 m. Material consumption approx. 1.1 m² / m² floor area.

Roll width: 1.25 m

Roll length: 32 m

Art.-No.	Description	Unit Size	Price
FB 2037	Sealant Katja Sprint	40 m ²	6.50 €/m ²
FB 2038	Katja Connecting Strip	15 m	4.80 €/Ro

Additional insulation

Laying as additional insulation for the production of a floor construction in accordance with EnEV certification. Type and thickness in accordance with object specification.

Art.-No.	Description	Unit Size (m ²)	R-Value (m ² K/W)	Price
FB 2017	PUR 20, WLG 025	18.00	0.80	17.30 €/m ²
FB 2004	PUR 30, WLG 025	11.52	1.20	21.30 €/m ²
FB 2002	PUR 40, WLG 025	8.64	1.60	22.50 €/m ²
FB 2006	PUR 50, WLG 025	7.20	2.00	27.00 €/m ²
FB 2052	EPS 040, 20 mm	12.00	0.50	4.60 €/m ²
FB 2053	EPS 040, 30 mm	8.00	0.75	6.50 €/m ²
FB 2054	EPS 040, 40 mm	6.00	1.00	8.80 €/m ²
FB 2055	EPS 040, 50 mm	4.50	1.25	11.40 €/m ²
FB 2056	EPS 040, 60 mm	4.00	1.50	13.80 €/m ²
FB 2052-35	EPS 035, 20 mm	12.00	0.57	5.10 €/m ²
FB 2053-35	EPS 035, 30 mm	8.00	0.86	7.50 €/m ²
FB 2054-35	EPS 035, 40 mm	6.00	1.14	9.90 €/m ²
FB 2055-35	EPS 035, 50 mm	4.50	1.43	12.50 €/m ²
FB 2056-35	EPS 035, 60 mm	4.00	1.72	14.50 €/m ²

Kemmer GmbH

Kölner Straße 60
50859 Cologne-Lövenich

Telephone: +49 (0) 22 34 / 999 19 - 0

Telefax: +49 (0) 22 34 / 999 19 - 20

Germany

www.climalevel.com

www.dinotherm.com

